

SITE PLAN

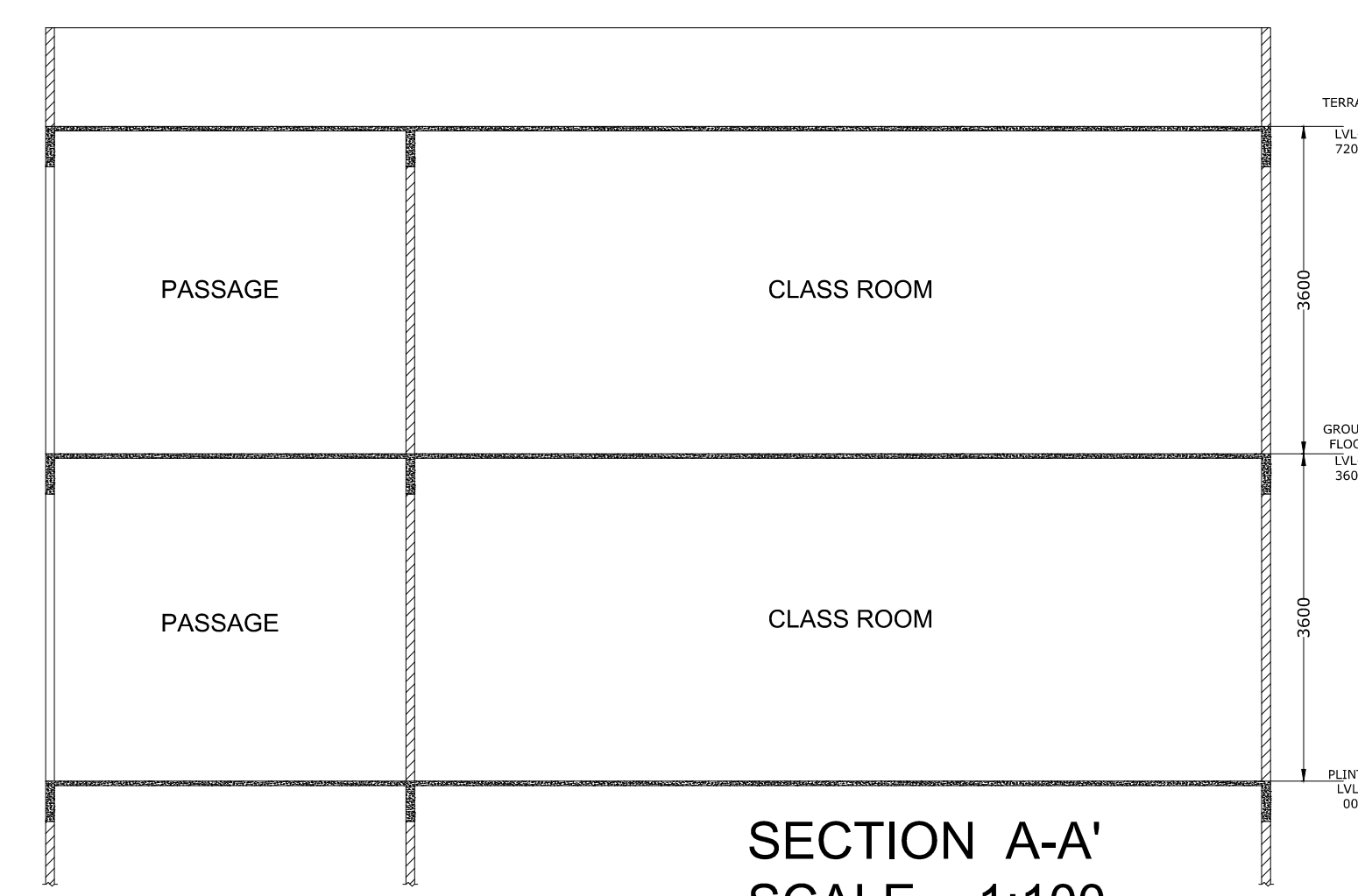

SECTION A-A'
SCALE - 1:100

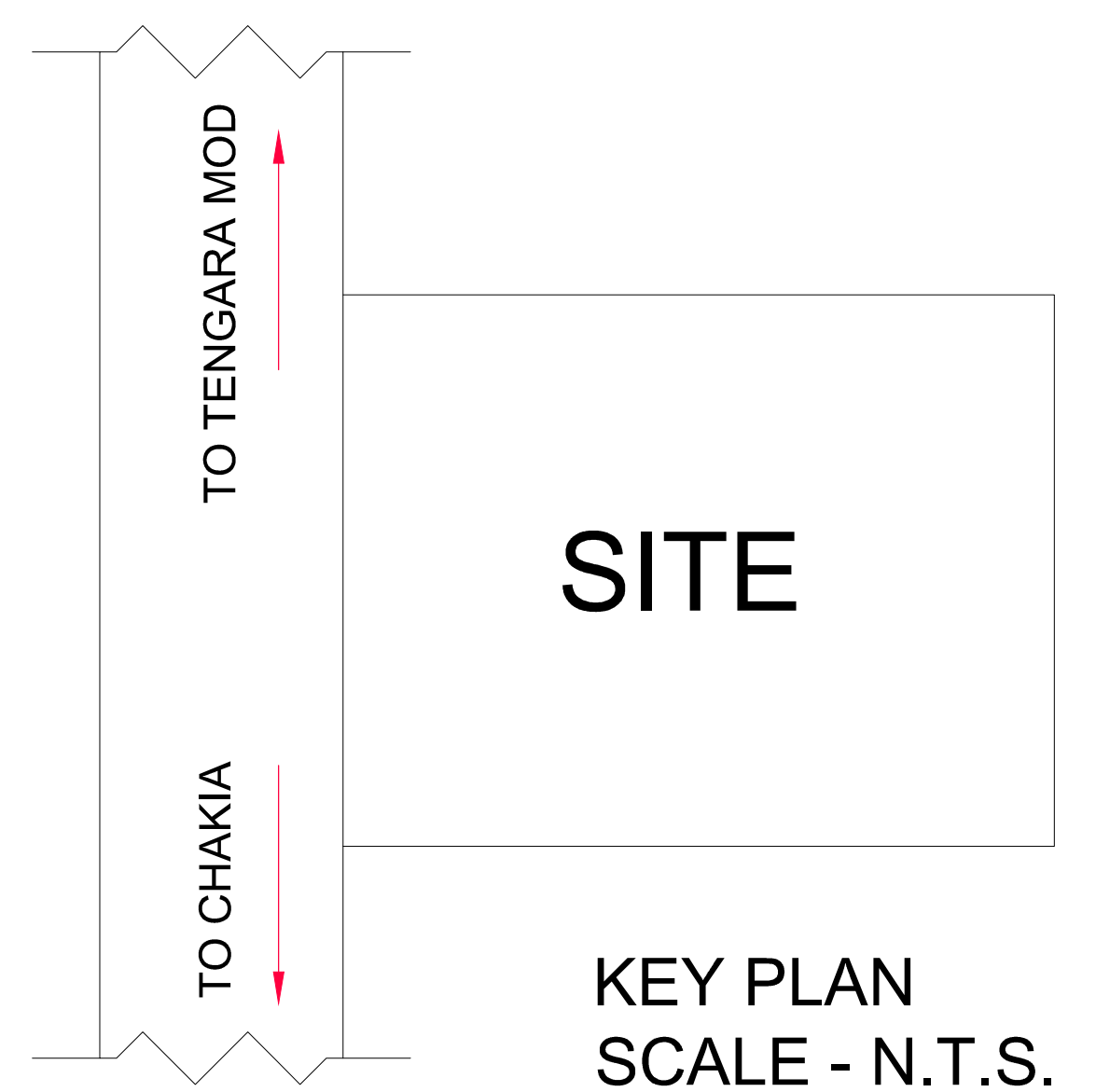

SITE
KEY PLAN
SCALE - N.T.S.

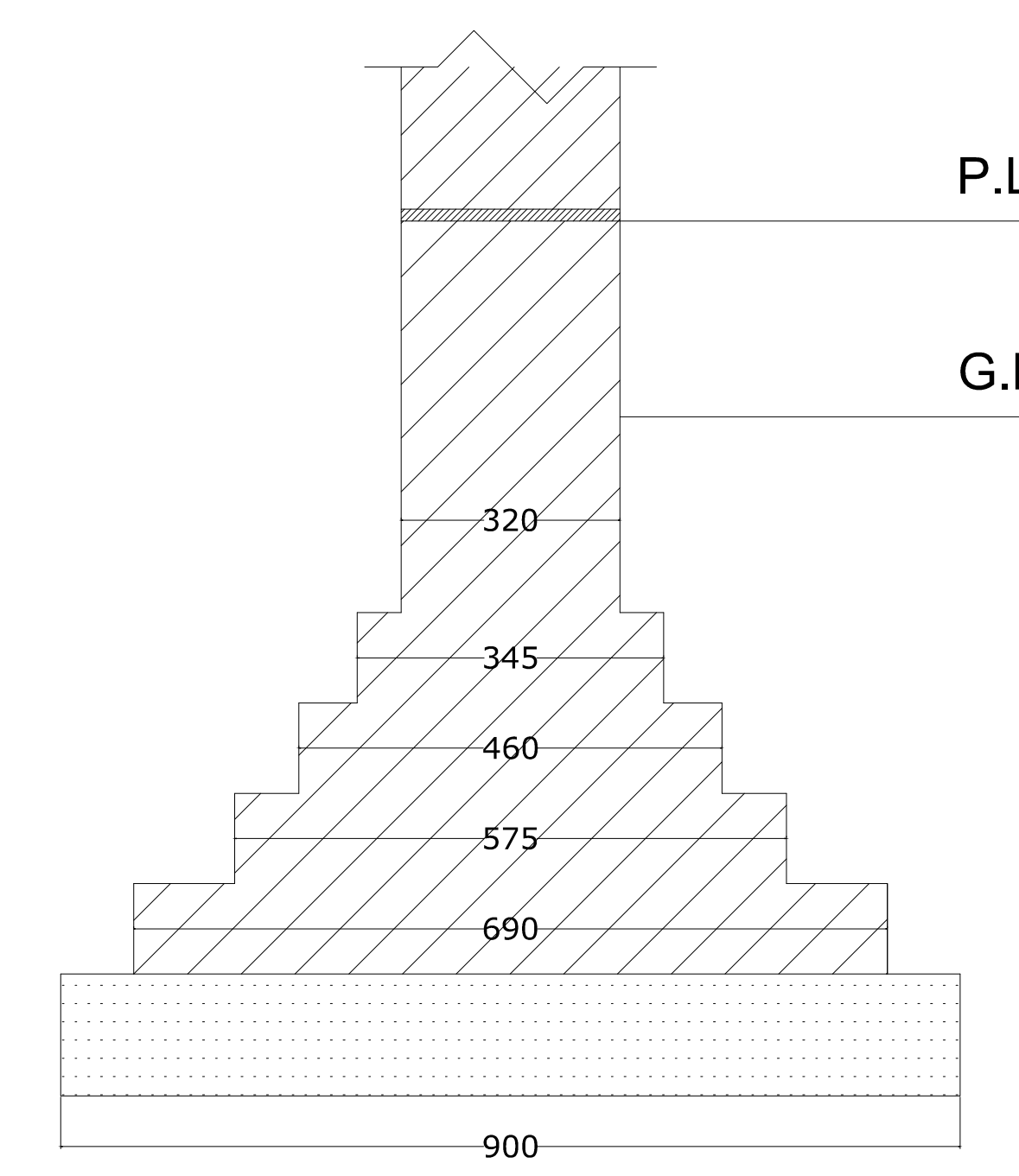

FOUNDATION DETAILS
NOT TO SCALE

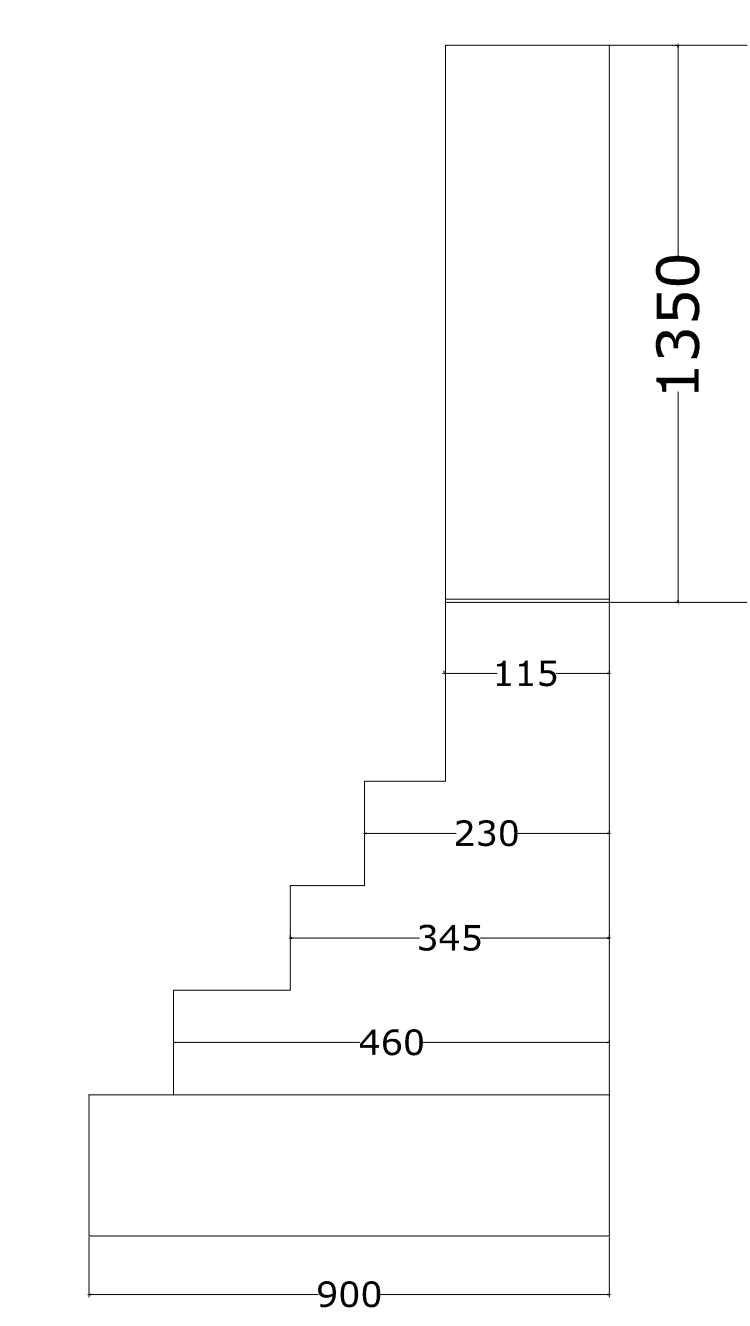
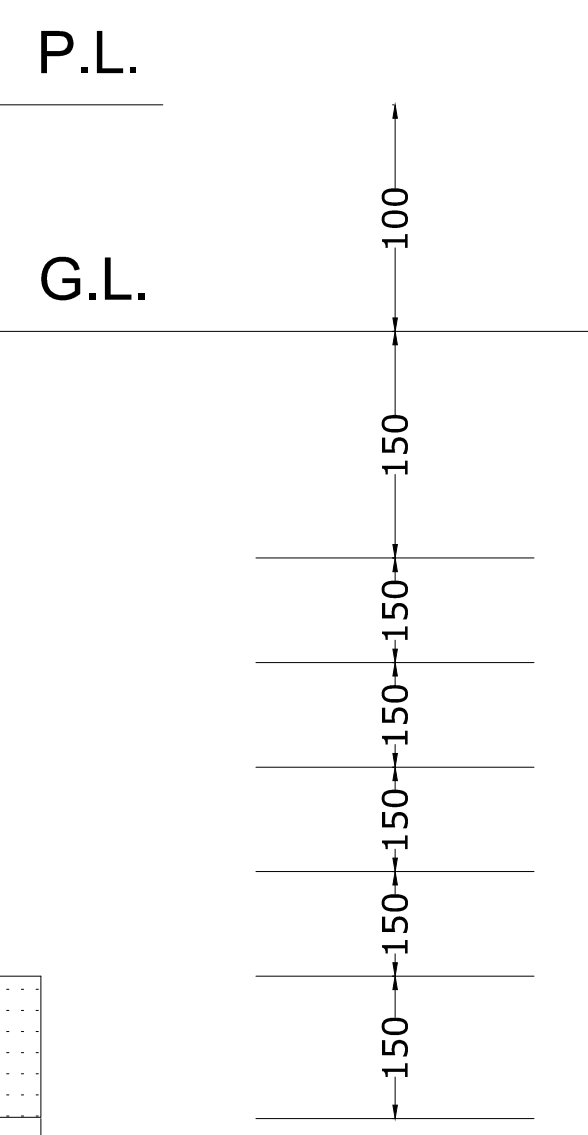

BOUNDRY WALL DETAILS
NOT TO SCALE

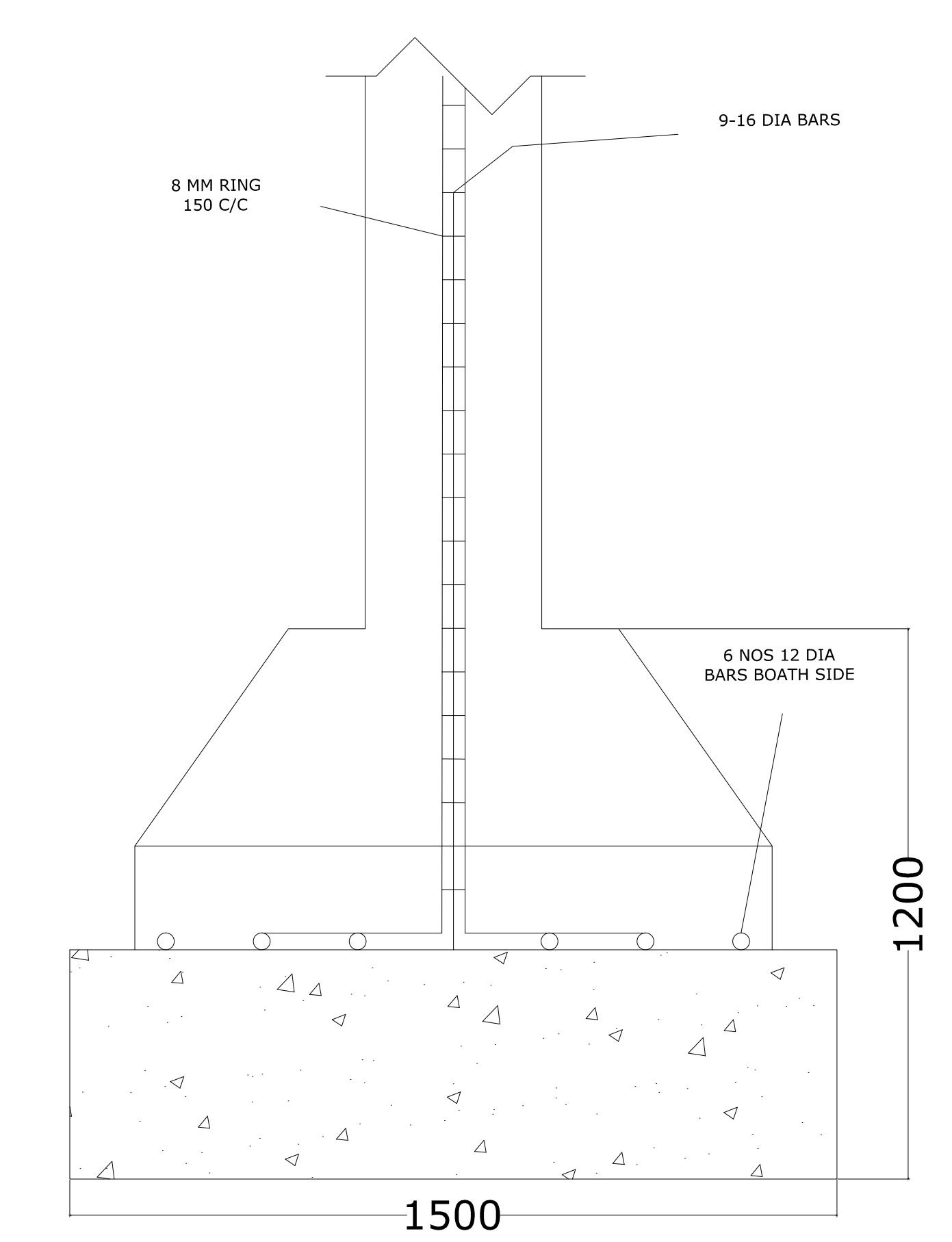

R.C.C. FOUNDATION
NOT TO SCALE

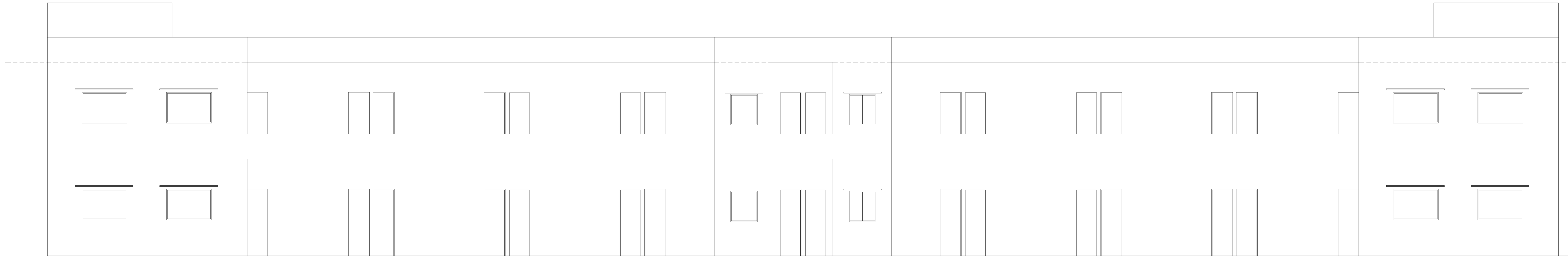

FRONT
ELEVATION



GROUND FLOOR PLAN

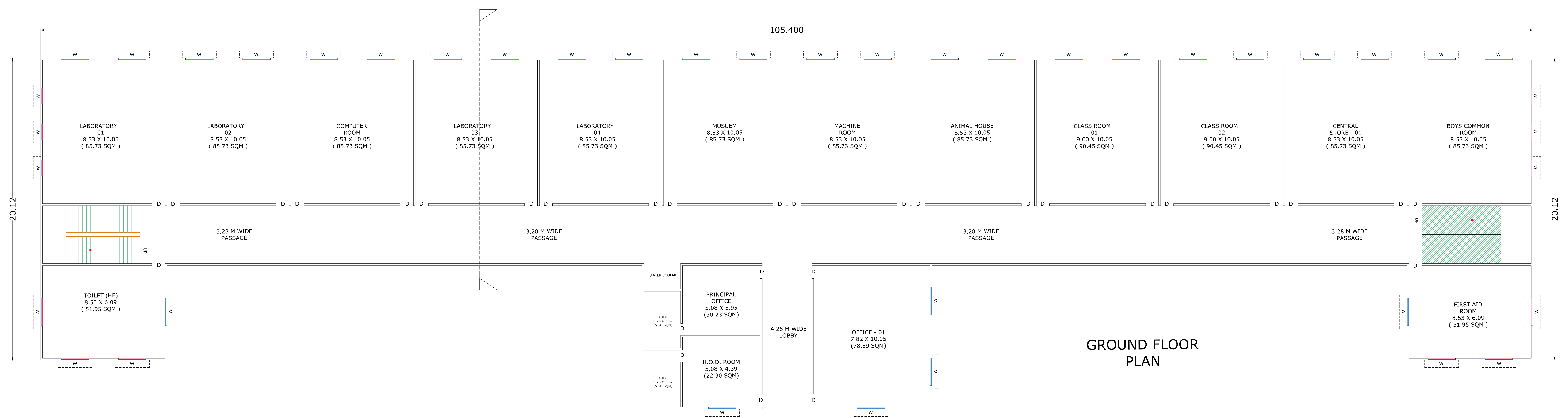

GROUND FLOOR PLAN

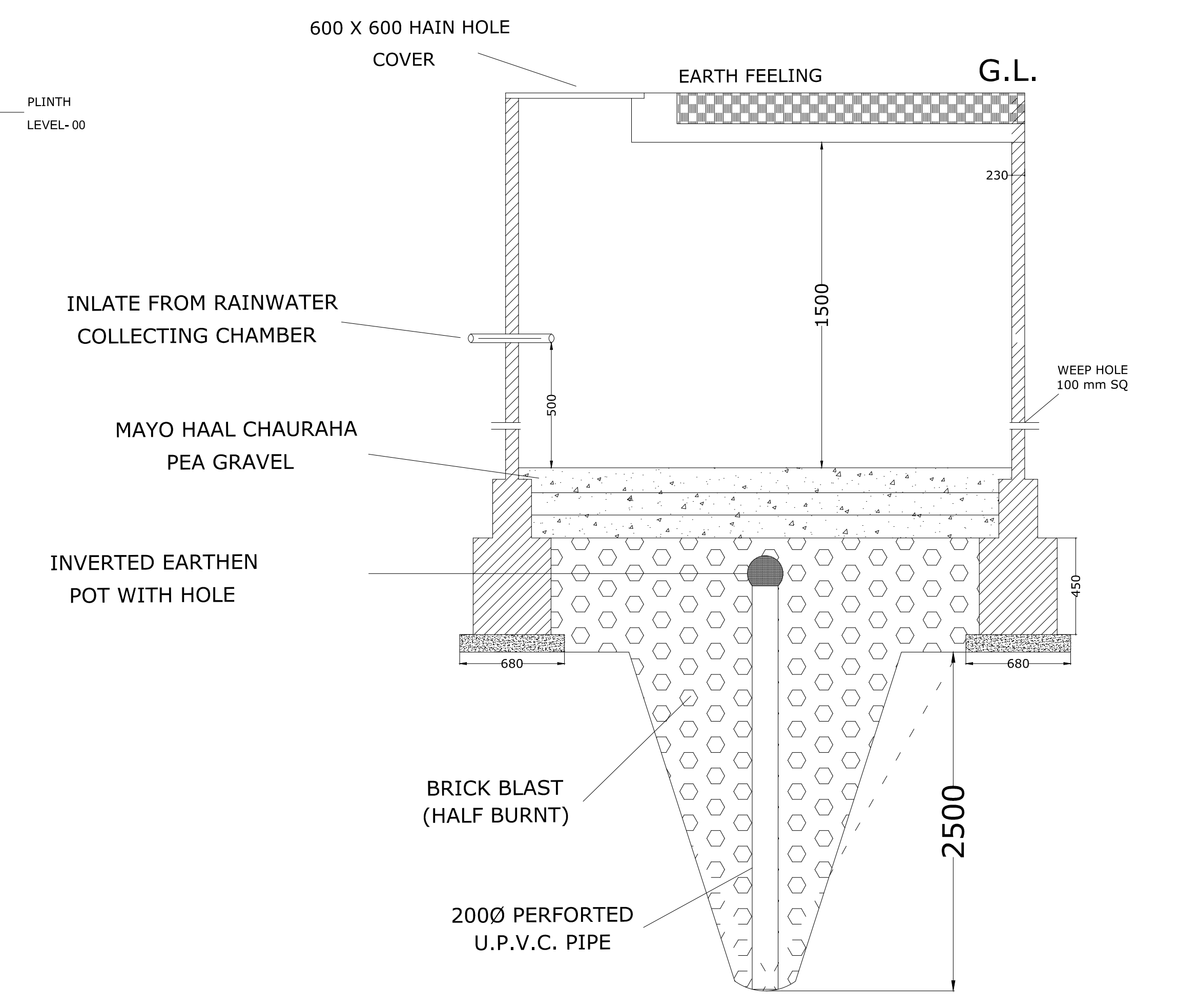

PLAN
WATER RECHARGING PIT
NOT TO SCALE
6.00 MT DEEP

